

UNI-T®



UTi720E/ UTi730E

Professional Thermal Imager

User Manual

Preface

Dear user:

Thank you for selecting the brand new UNI-T E Series Infrared Thermal Imaging Device. In order to use this product correctly, please read the full text of this manual carefully before using, especially the part about "Safety Precautions".

If you have read the full text of this manual, it is recommended to keep this manual properly with the accessories of the thermal imaging device or in a place where you can refer to it at any time for future use.

Limited warranty and limited liability

Our company guarantees that the product is free from defects in material and workmanship for one year from the date you purchase it. For the warranty, it does not cover the damage caused by accident, negligence, misuse, modification, contamination or abnormal operation or handling etc.. The Distributor shall not be entitled to give any other guarantee in the name of the Company. If you need warranty service during the warranty period, please contact the authorized service center nearby to obtain the product returning authorization information; and then send the product to the service center with the product problem description.

This guarantee is the only compensation you can get. Otherwise, the Company does not provide any warranty, express or implied, like the implied warranty for the particular purpose. Meanwhile, the Company shall not be liable for any special, indirect, incidental or consequential damage or loss arising out of any cause or conjecture whatsoever. For some states or countries do not allow limitations on implied warranties and incidental or consequential damages, the above limitations and requirements may not apply to you.

Contents

1. Performance indicators.....	4
2. Structure	6
3. Display instructions.....	7
4. Power on-off.....	7
5. Instruction of configuration menu	8
6. Marking tool	8
7. Image mode.....	9
8. Swatches switching	9
9. Temperature measuring tool.....	9
10. Vitta tool.....	11
11. Photo view and edit.....	11
12. Digital amplification & fusion ratio adjustment.....	12
13. System setup	12
13.1 Camera mode.....	12
13.2 Units	13
13.3 Parameters.....	13
13.4 Alarm	14
13.5 QR CODE.....	15
13.6 Language.....	15
13.7 Date and time	16
13.8 Wi-Fi	16
13.9 USB mode	16
13.10 Brightness.....	16
13.11 Automatic Shutdown.....	17
13.12 Factory reset	17
13.13 Formatting	17
13.14 About	18
14. SD Card	18
15. Maintain	18
16. Safety precautions.....	18
17. FCC Compliance statement	19
18. Common emissivity table.....	19

1. Performance indicators

UTi720E:

Mode	Low temperature scale (-20°C~ 150°C) High temperature scale (0°C~ 550°C (manual selecting scale))
Thermal imaging pixel	256*192 (49152)
IFOV	3.8mrad
Focal length	3.2mm
Sensitivity	<50mK @25°C
Frame frequency	<25Hz
Precision	-10°C~550°C, room temperature of 25°C, and ±2°C/±2% to take the maximum value
Temperature measurement scale	- 20°C ~ 550°C (-4°F~1022°F)

UTi730E:

Mode	Automatic gain
Thermal imaging pixel	320*240 (76800)
IFOV	3mrad
Focal length	4.0mm
Sensitivity	<65mK @25°C
Frame frequency	9Hz
Precision	-10°C~400°C, room temperature of 25°C, and ±2°C/±2% to take the maximum value
Temperature measurement scale	-40°C~400°C (-40°F~752°F)

UTi720E/UTi730E:

Sensor	Un-cooled vanadium oxide
Display resolution	640*480
Emissivity	0.95 (default) 0.01~ 1.00
Visible light pixel	2 million
Thermal imaging pixel size	12µm
Swatches	Iron red, rainbow, black heat, white heat, red heat, lava, and high contrast rainbow
Infrared spectral bandwidth	8~14µm
Field of view	HFOV 56°

Focusing mode	Free Focus
Digital zoom	2x,4x
Temperature Sweep	5 points,3 rectangles,3 circles, and1 line (add up to 6)
Vitta tool	Automatic isothermal, proportional isothermal, downward isothermal, upward isothermal, interval isothermal, and manual isothermal
Temperature display	Center point temperature, and high/low temperature tracking
Temperature measurement unit	°C(default)、°F、K
High and low temperature alarm	Yes (LED lighting alarm, and LCD animation alarm)
Image mode	Thermal imaging, visible light, fusion, and picture in picture
Image capture mode	Take pictures, and automatically take pictures
Image save format	JPG
Image browse	Temperature analysis, changingswatches, and remarks
QR code scanning	Yes
USB communication	Type-c USB (Charging, real-time image and USB disk storage)
WIFI	Yes
PC projection screen	Yes
PC analysis software	Yes (live image, photo download and analysis)
Mobile phone APP	Yes (Photo download and analysis)
LED lighting	Yes
Language	English/French/German/Spanish/Russian
Authentication	CE FCC UKCA ROHS
Operation temperature	0°C~ 50°C (32°F~ 122°F)
Storage temperature	-10°C~ 60°C (14°F~ 140°F)
Operation humidity	10%~95%RH (Non - Condensing)
Battery	5200mAh(Detachable battery pack)
Auto Power -Off	Yes
Service duration	More than 3 h
Charging period	Less than 4h
Charging voltage/current	5V/ 1.5a 9V/1A 12V/1A (supported only with standard USB charging below QC2.0)
Image saving	The microSD card supporting 32 GB for maximum
IP level	IP54 (IEC 60529:1989+A1:1999+A2:2013)
Drop height	2m

2. Structure

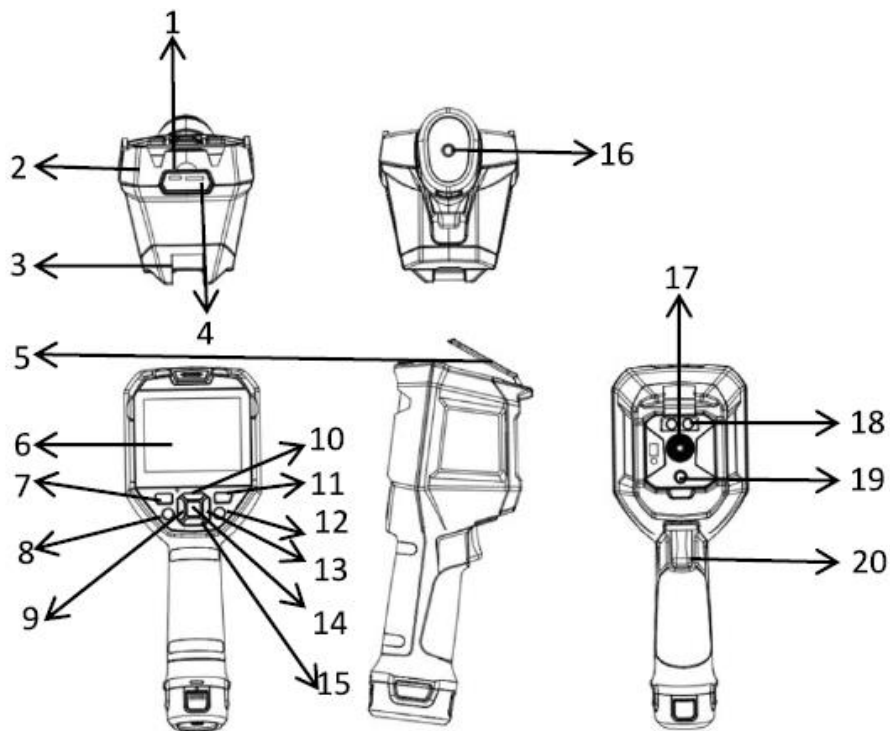

No.	Description	No.	Description
1	The USB Type - C interface	11	Photo browsing button
2	Upper casing	12	Back key
3	Lower casing	13	Right key
4	SD card slot	14	SET key
5	Interface protection cover	15	Down key
6	LCD display	16	Bracket fixed screw hole
7	Start key	17	Infrared thermal image window
8	Lighting key	18	Lamp
9	Left key	19	Visible light camera window
10	Up key	20	Photo trigger key

3. Display instructions

- Display resolution: 640x480

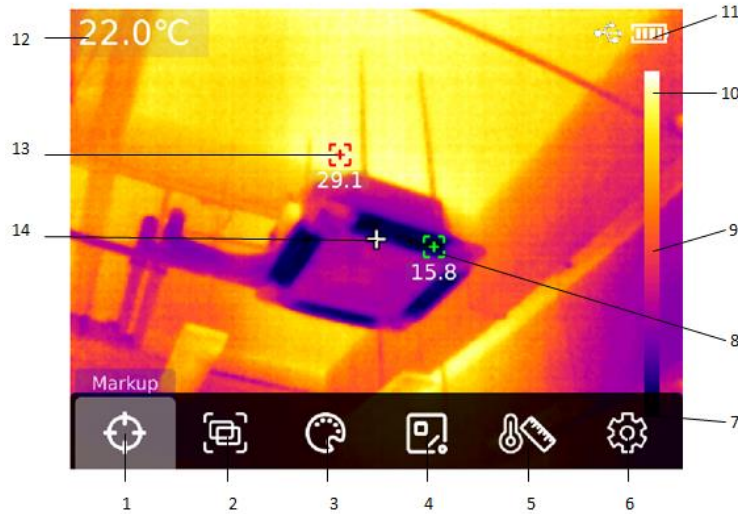

No.	Description	No.	Description
1	Marking tool	8	Automatic tracking of the minimum point
2	Image mode	9	Color temperature bar
3	Swatches switch	10	Upper limit of swatches scale
4	Temperature measuring tool	11	Electric quantity
5	Vitta tool	12	Temperature of the measurement central point
6	System setup	13	Automatic tracking of the maximum point
7	Lower limit of swatches scale	14	Temperature measurement central point

4. Power on-off

Long press the "Power button" for 5 seconds to start up the thermal imaging device (if start up the device just now, the device is not being used for a long time or after the measurement environment changes, it will take up 30 minutes for starting up the device to measure the temperature). Long press the "Power button" for 5 seconds to turn off the thermal imaging device. When the thermal imaging device is in low power mode, the reminder of low power will pop up. At this time, the thermal imaging device needs to be turned off to charge. When the thermal imaging device is in low power mode all the time, the thermal imaging device will automatically be shut down.



5. Instruction of configuration menu

Configuration options for main menu



Main page of the thermal imaging device

1. Press "SET key" on the home page to display the main menu
2. Press "Left/right key" to select sub-menu
3. Press "SET key" to enter the corresponding sub-menu
4. Press "Left/right key" to select sub-menu Settings
5. Press "SET key" to select Settings
6. Press "Back key" to return to the previous level and save the Settings
7. Press "Back key" again to return to the home page of thermal imaging

Main menu:



Sub-menu:

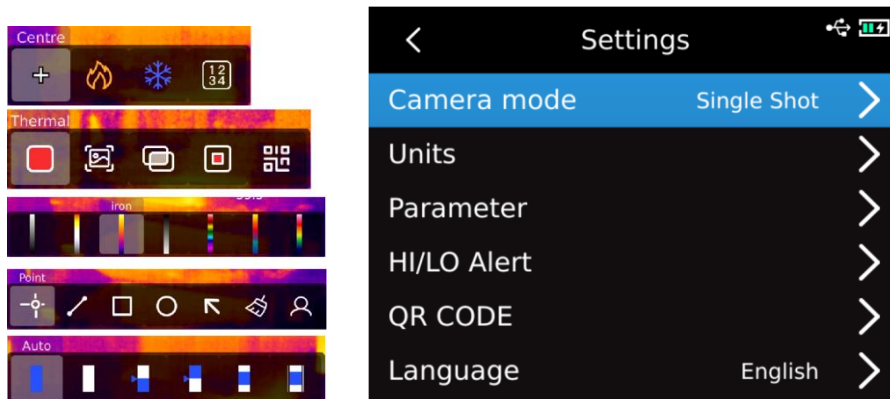

6. Marking tool

If you need to use the center point/high/low temperature tracking/temperature display function, press "SET key" to pop up the main menu options, select "Marking tool" by using left/right key, and then press "SET key" to enter the marking tool sub-menu options and make selection by using left/right key. (For example: Press "SET key" to select "Center point". When cross collimation appears, it means that the center point cursor is opened. Press "SET key" again, the cross collimation disappears, indicating that the function of the center point cursor is closed.



7. Image mode

Press "SET key" to pop up the main menu, select "Image mode" by using "Left/right key", and then press "SET key" to enter the sub-menu options of image mode. You can make selection by using left/right key. For example, press "SET key" to select "Thermal imaging" to switch the image to thermal imaging mode. (In the fusion mode, you can adjust the fusion ratio by using "Left/right key" and adjust the fusion distance by using "Up/down key". In picture in picture mode, you can change the position and size of the picture in picture by selecting Move or Stretch by using "Left/right key". Press "SET key" to select "QR code", you can manually enter the QR code or scan the code to obtain QR code, and select "Cancel" to return to the main page).

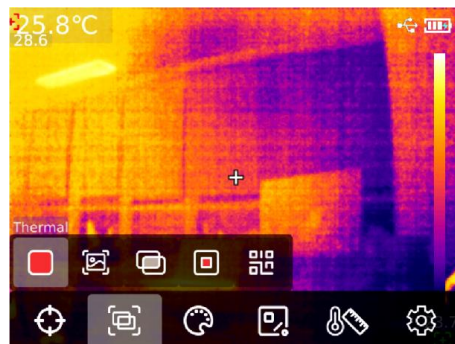

8. Swatches switching

Press the "SET key" to pop up the main menu options, select "Swatches Switch" by using "Left/right key", select the required swatches by using "Left/right key", and there are seven swatches available: white hot, red hot, iron red, black hot, high rainbow, lava, and rainbow.

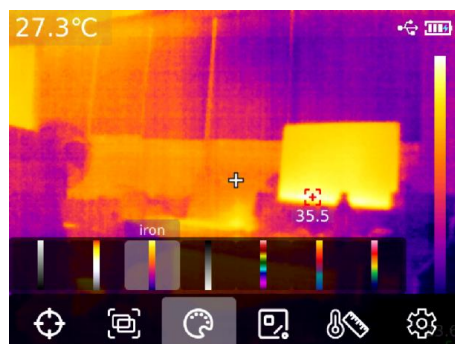

9. Temperature measuring tool

Press the "SET key" to pop up the main menu options, select "Temperature measuring tool" by

using "Left/right key". By using "Left/right key",select the analysis object type (including point temperature measurement, line temperature measurement, rectangle, and circle) and select the target (this function can be used only when the analysis object is added on the home page). Clear all and preset tools.

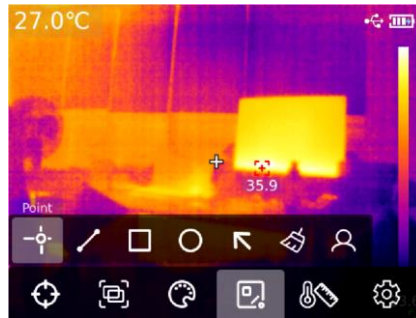

Press"SET key" to add point, line, rectangle and circle temperature measurement analysis objects, and the sub-menu bar of "Select thetarget" will pop up automatically. Select the required functions by using "Left/right key", including following functions: select, move, stretch (for the point temperature measurement analysis object, it cannot be stretched), comparing (for the point temperature measurement analysis object, it can only be compared with point temperature measurement analysis object, and corresponding comparison information will be displayed on the right after comparison), and delete (only the currently selected temperature measurement analysis object can be deleted). After adding the temperature measurement analysis object, the corresponding temperature information will be displayed on the left side. When select the line temperature measurement analysis object, the temperature curve of the line area will be displayed in the lower left corner.

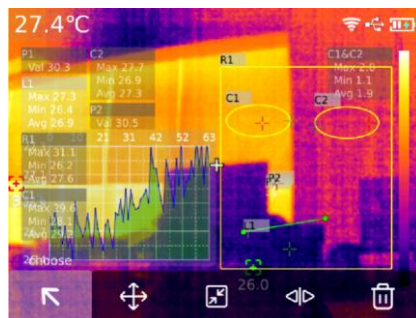

After pressing"SET key" to clear all functions, all temperature measurement analysis objects on the current page will be cleared. If there is the temperature measurement analysis object on the home page, press "SET key" to select the preset tool, and the "Save Tool" prompt box will pop up. If you select OK, the current analysis object will be saved and the preset tool can be used next time. If there is no temperature analysis object on the home page, press"SET key" to select the preset tool, and the Read Tool dialog box will be displayed. If you select OK, the preset tool saved last time will be added to the home page.

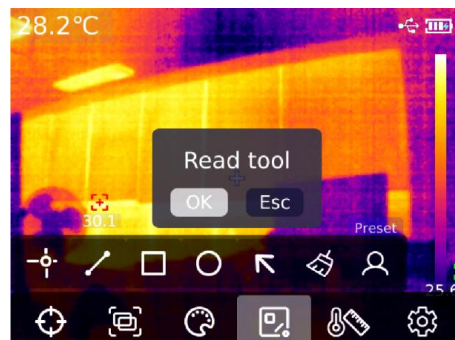

Note: The maximum of five point temperature measurement analysis objects can be added. For the line temperature analysis object, it can be added only one. The maximum of three rectangular and circular temperature analysis objects can be added. The total number of temperature measurement analysis objects cannot exceed six. If the number of analysis objects exceeds the threshold, will not add any analysis objects and will display the message "Out number".

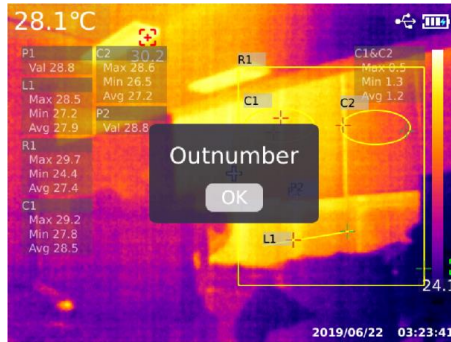

10. Vitta tool

Press "SET key" to pop up the main menu, and select "Vitta Tool" by using "Left/right key". Select the desired vitta tool by using "Left/right key". Six isothermal modes can be selected: Auto isothermal, Proportional isothermal, Down isothermal, Up isothermal, Interval isothermal, and Manual isothermal.

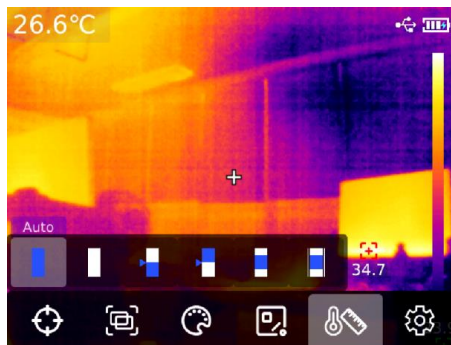

11. Photo view and edit

On the main page, press the "Photo view key" to enter the multimedia view. Press "Up/Down key" to select all photos/videos or other folders, and press the "SET key" to enter. Press "Up/Down/Left/Right key" to select the picture you want to view, press "SET key" to view the picture, and switch the picture using "Left/right key".

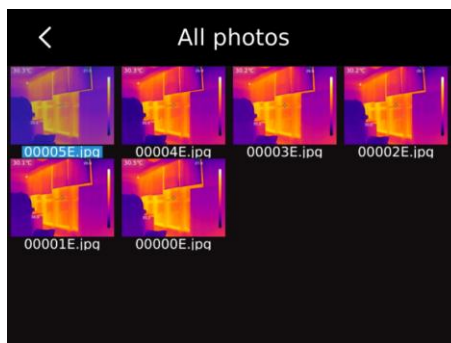

Press "SET key", the picture interfacesub-menu will appear, press "Left/right key" to select the photo message (for UTi720E, you can view the picture shooting time, modify time, emissivity, infrared resolution, ambient temperature, humidity, reflection distance and QR code, remarks and other

information. For UTi730E, you can view the photo shooting time, modify time, emissivity, infrared resolution, QR code, remarks and other information), modify remarks (after adding remarks, you can view them in the photo message), state editing (it can be used for second editing of the marking tool, image mode, swatches switch, temperature measurement tool, vitta tool and other functions on the original picture, and the function is basically the same as the main page function), QR code (it can be added to the existing QR code for picture classification. After classification, you can view the corresponding QR code classification pictures in different folders, and can also delete the QR code of the current picture or add a new QR code. The new QR code is not added here for folder classification), and delete photos.

Note: After editing on the status editing page, press "SET key" to open the status editing sub-menu, select Recovery by using "Up key", and press "SET key" to restore the picture to the initial state. After editing, press "Back key". The message Exit or Not will be displayed. If you select Exit, the editing page is directly exited. If you select Save, the message "Cover or not?" will be displayed. If you select Cover, change the original image and save it, then back to the view page. If you select New, the original image will not be changed, one new image will be added and back to view page.

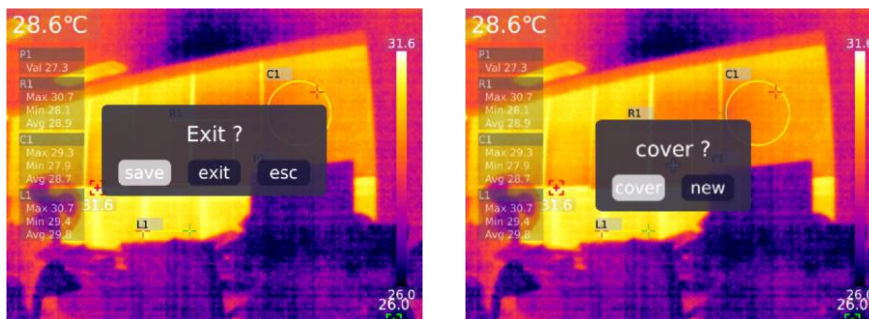

After adding QR code, press "Back key" and the message "Save and exit" will pop up to confirm, then the added QR code will be saved. If you select Cancel, the QR code will not be saved and exit the QR code editing page. For QR code added here, it will not be saved to the existing QR code category. If you need to modify the existing QR code, just modify it in the Settings.

12. Digital amplification & fusion ratio adjustment

On the home page, press "Up key" to enlarge the screen, and the corresponding magnification factor will be displayed in the upper right corner of the screen. For the switch of magnification factor, it is switched with the cycle of 1X, 2X, 4X and 1X.

On the home page, press "Left and right key" to adjust the degree of fusion. The degree of fusion adjustment is 0%, 25%, 50%, 75% and 100% respectively.

13. System setup

Press "SET key" to enter the sub-menu, select different Settings by using "Up/Down key". Press "SET key" to enter the secondary page for setting, including: camera mode, units, parameters, alarm, QR CODE, language, date, time, Wi-Fi, USB mode, brightness, automatic shutdown, factory reset, and about Settings. Click "Back key" to return to the first-level menu on the setting page, and click the "Back key" again to return to the main menu.

13.1 Camera mode

After entering the first level menu on the Setting page, select "Camera mode" option, press "SET key" to enter the sub-menu of "Camera Mode", and use "Up/Down key" to select Photo/Auto photo. If select automatic photo taking, press "Up/Down key" to set the automatic photo taking interval (10s-

1000s is optional).

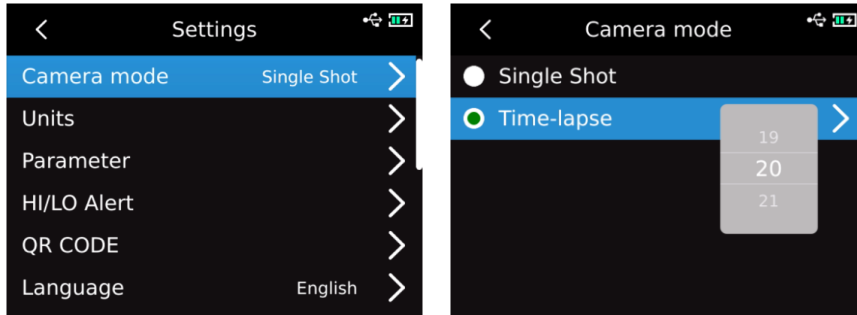

13.2 Units

After entering the first-level menu on the Settings page, select "Units" option and press "SET key" to enter the sub-menu of "Units". Use "Up/Down key" to select the temperature/distance. When select a temperature, press "Up/Down key" to select the temperature unit (°C/K/°F). For distance units, they cannot be changed.

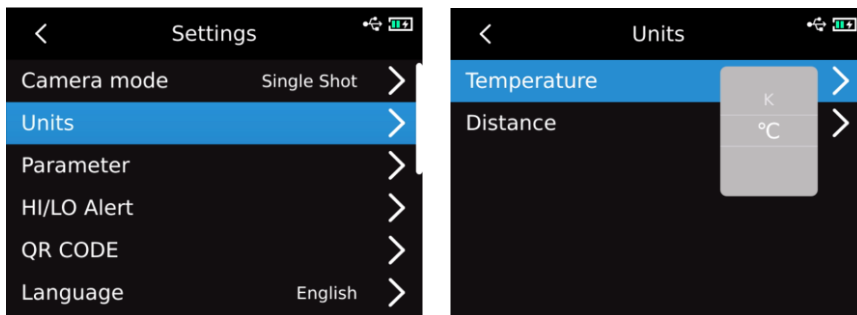

13.3 Parameters

UTi720E:

After entering the first-level menu of the Settings page, select the "Parameter" option and press the "SET key" to enter the sub-menu of "Parameter". Select emissivity/ambient temperature/reflected temperature/relative humidity/object distance/Temperature scale through the "Up/Down key". Press "SET key" to select the parameter you want to change, and press "Up/Down key" to select the value for the parameter. When setting the object distance parameter, press the "SET key" to enter the "Object distance" sub-menu, and then use the "SET key" and the "Up/Down key" to modify the parameter.

Low temperature scale: -20°C~150°C

High temperature scale: 0~550°C

Note: It takes about 20 seconds to switch the temperature scale. Wait until the switch is stable before performing other operations or measuring the temperature.

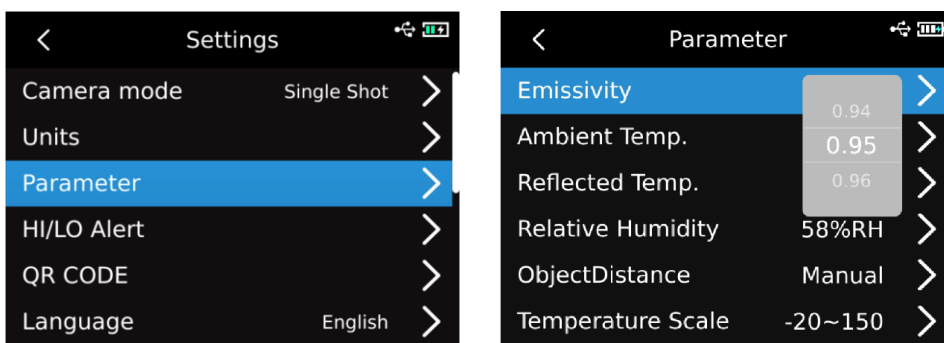

1. Please refer to 18 Emissivity table;
2. If you cannot determine which value to use, it is recommended to use the following default values:
 Emissivity 0.95
 Ambient temperature 25°C
 Reflected temperature 25°C
 Relative humidity 55%RH
 Object distance 0.25m

Note: Emissivity and reflected temperature are the two most important parameters that need to be set correctly. If you are in doubt, please use the default values.

UTi730E:

After entering the first-level menu of the Settings page, select "Parameter" option and press "SET key" to enter the sub-menu of "Parameter". Select emissivity/object distance through "Up/Down key" and press "SET key" to select parameters to be changed. Press "Up/Down key" to select the value for the parameter. When setting the object distance parameter, press "SET key" to enter the sub-menu of "Object distance", and then use the "SET key" and the "Up/Down key" to modify the parameters.

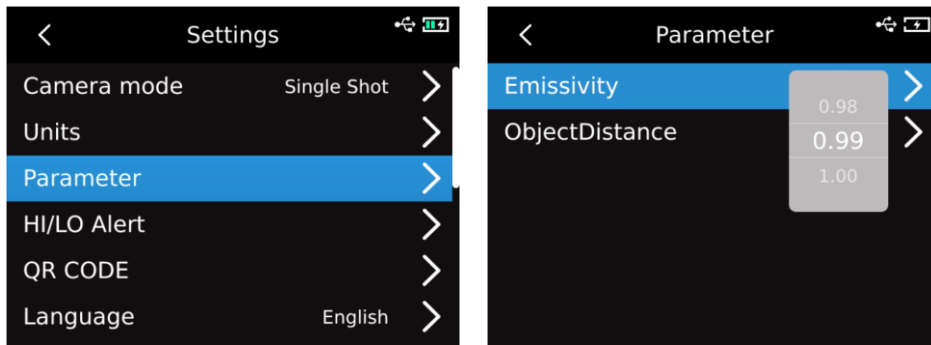

13.4 Alarm

After entering the first-level menu on the Setting page, select "Alarm" option, press "SET key" to enter the sub-menu of "Alarm", and select the high temperature alarm/low temperature alarm /LED alarm by using the "Up/Down key". When selecting high temperature alarm/low temperature alarm, select high/low temperature alarm value by using "Up/Down key", press "SET key" to select, and set the required value by using "Up/Down key" (UTi720E: -20°C-550°C optional, and UTi730E: -40°C~400°C optional).

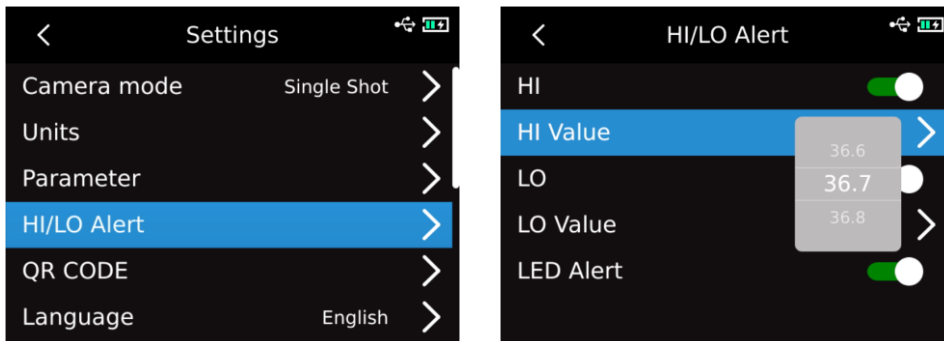

When the temperature of the measured object exceeds the high temperature alarm temperature value, the red positive triangle will pop up. When the temperature of the measured object is lower than the low temperature alarm temperature value, the green inverted triangle will pop up.



13.5 QR CODE

After entering the first-level menu on the Setting page, select "QR CODE" option and press "SET key" to enter the QR CODE sub-menu. Select different QR Codes by using "Up/Down key" and press "SET key" to enter the change page for QR CODE name /CODE.

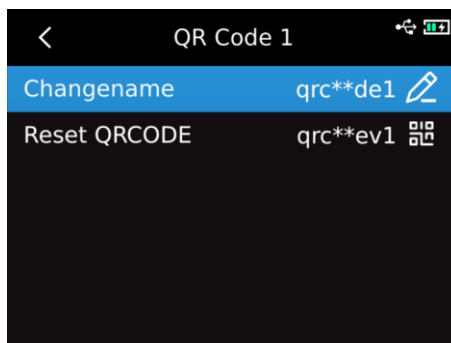
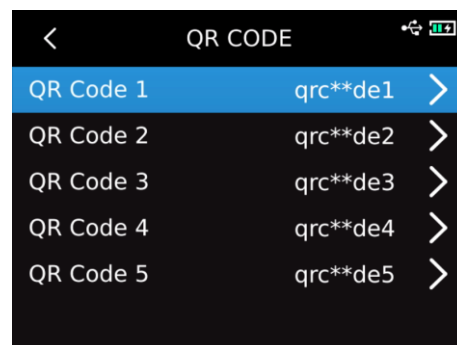
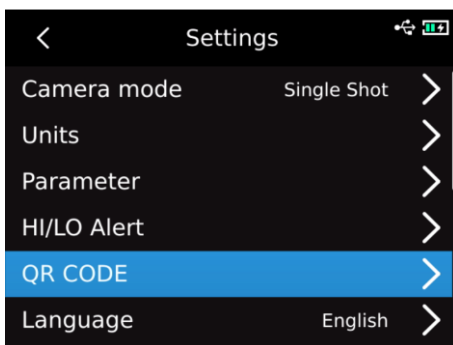

13.6 Language

After entering the first-level menu on the Setting page, select "Language" option and select English, French, German, Spanish, or Russian by using "Up/Down key".

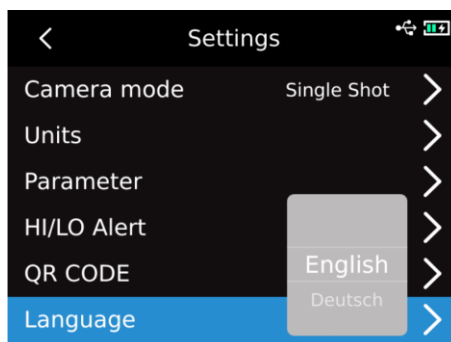

13.7 Date and time

After entering the first-level menu on the Setting page, select Date and Time and press "SET key" to enter the submenu of Date and Time. Press "SET key" to change the time system/date/time, and change the value by using "Up/Down key". For example, if you want to change the date, select the change of year/month/day by using "Left/Right key", and select the specified date by using "Up/Down key".

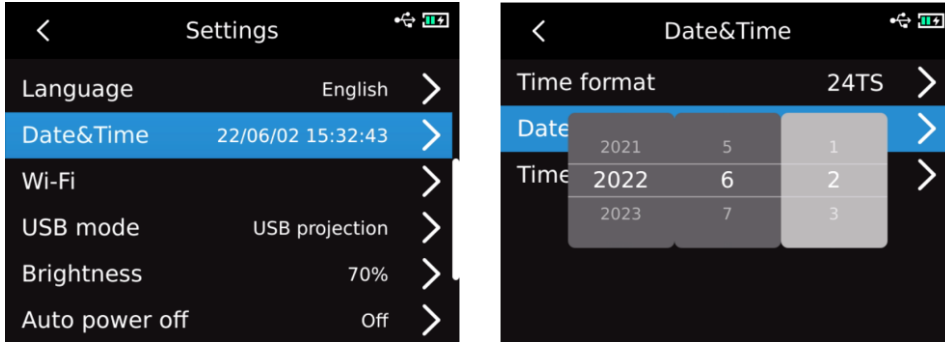

13.8 Wi-Fi

After entering the first-level menu on the Setting page, select Wi-Fi option and press "SET key" to enter the sub-menu. Press "SET key" to open the Hotspot, press "Down key" to select the Hotspot ID and password, and set up by using "SET key".

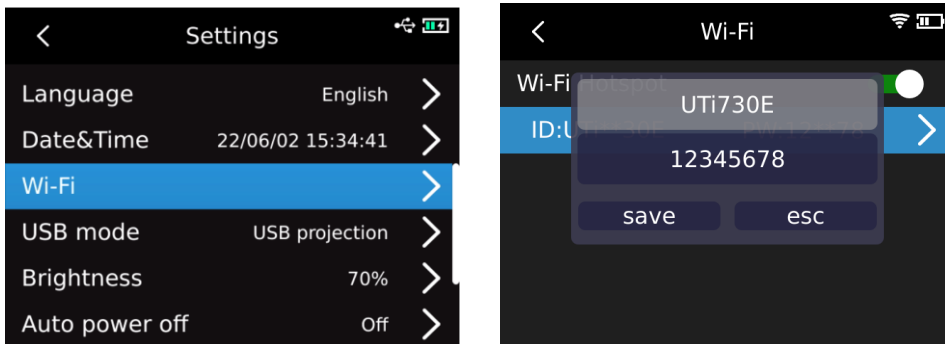

13.9 USB mode

After entering the first-level menu on the Settings page, select "USB mode" option and press "SET key" to enter the Sub-menu of "USB mode". Select "USB storage /USB Projection" by using "Up/Down key" and press "SET key" to select.

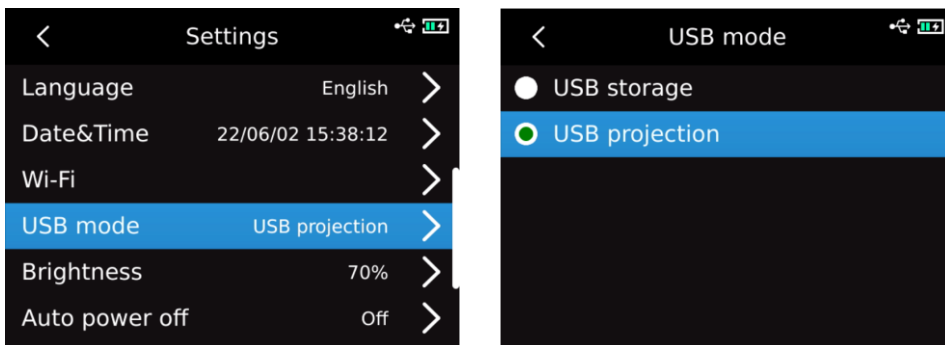

13.10 Brightness

After entering the first-level menu on the Setting page, select "Brightness" option, and select the intensity of brightness (1-100) by using "Up/Down key".

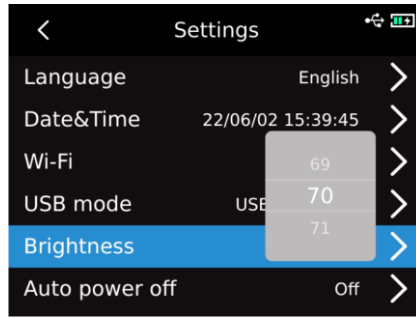

13.11 Automatic Shutdown

After entering the first-level menu on the Setting page, select "Automatic Shutdown" option, and select Off /5 /10 /20 /30 /45 /60 /90 by using "Up/Down key".

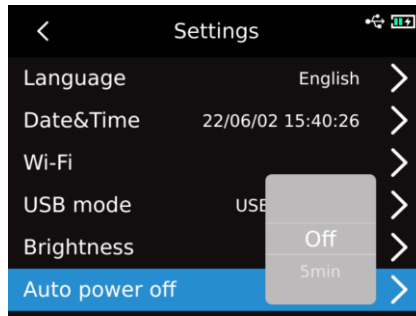

13.12 Factory reset

After entering the first-level menu on the Settings page, select the option of "Factory reset" option, press "SET key", and the prompt "Shutdown and factory reset" will pop up. If you select Yes, the device will automatically shut down, and the instrument will restore factory settings after manual startup.

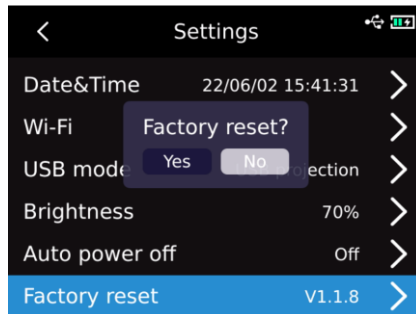

13.13 Formatting

After entering the first-level menu on the Settings page, select the "Formatting" option and press the "SET key". If there is SD card, the message "format SD card" will pop up? If you select Yes, will format the SD card. If there is no SD card , the message "Unknown"will be displayed.

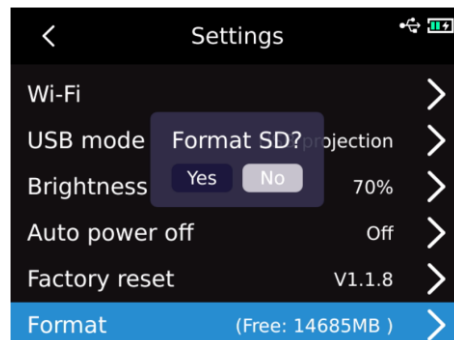
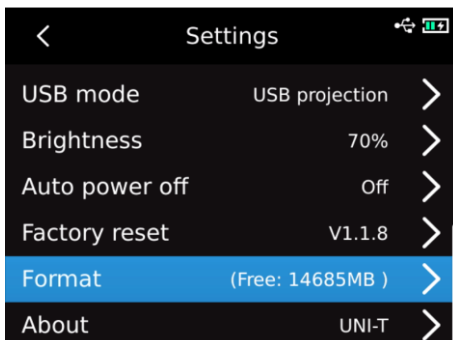

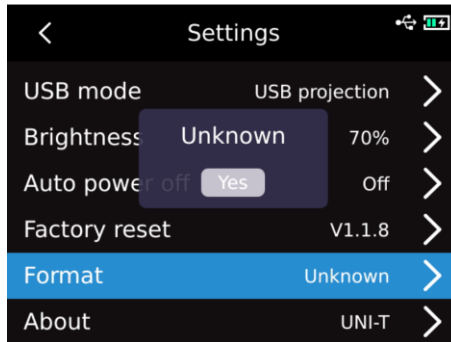

13.14 About

After entering the first-level menu on the Settings page, select "About" option and press "SET key" to enter the sub-menu of "Product Information". Then you can view product model, infrared resolution, hardware version, system version, SN, SD capacity and other related product information.

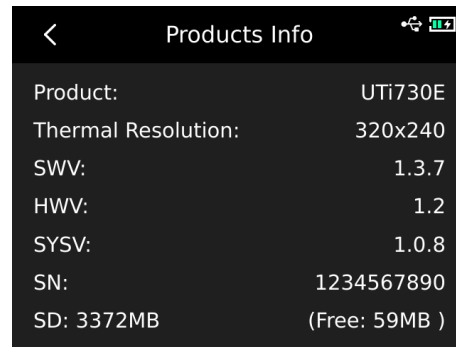
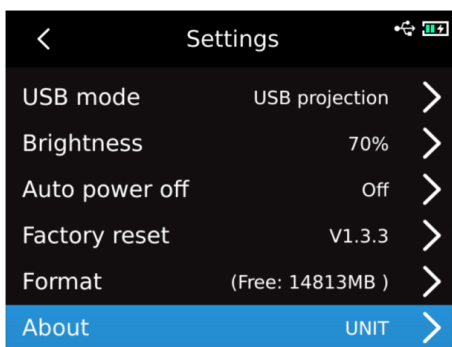

14. SD Card

The device supports microSD cards to store images. In order to prevent excessive image data from affecting the operating speed, should periodically copy backup data and clear the data in the card. In order to avoid data abnormalities caused by hot swap, do not remove or insert the SD card repeatedly. Try to remove or insert the SD card when it is powered off. If you remove the SD card when viewing or operating an image, the message "SD card is lost" will be displayed.

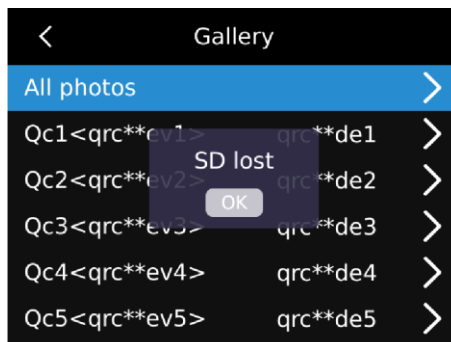

15. Maintain

Clean the structural housing with the damp cloth or weak soapy solution. Do not use the grinder, isopropyl alcohol or solvent to clean the lens/window of the instrument housing.

16. Safety precautions

In order to guarantee the accurate measurement results, please read the instructions carefully.

Please be sure to use the product according to the instructions, otherwise the product will not be free of warranty after damage. Do not use the instrument in inflammable, explosive, humid or corrosive environment. Do not continue to use the instrument when it is damaged, broken or corrected, which will cause wrong test results. Obtain the actual temperature by referring to the radiation coefficient information; otherwise, the measured temperature may be inaccurate.

Do not aim the lens at the hot light source, like the sun, so as to avoid damage to the lens or thermal imaging detector. Do not use the product in an extremely hot, cold, dusty, or high-humidity environment. For specific requirements on temperature and humidity, please see the product parameter table.

The system supports USB cable to charge the device, but in order to improve charging efficiency, it is recommended to remove the battery pack and charge the battery pack separately.

17. FCC Compliance statement

This device complies with Part 15 of the FCC Rules. Operation is subject to the following two conditions: (1) this device may not cause harmful interference, and (2) this device must accept any interference received, including interference that may cause undesired operation.

18. Common emissivity table

Material	Emissivity	Material	Emissivity
Wood	0.85	Black paper	0.86
Water	0.96	Poly carbonate	0.8
Brick	0.75	Concrete	0.97
Stainless steel	0.14	Copper oxide	0.78
Adhesive tape	0.96	Cast iron	0.81
Aluminium plate	0.09	Rust	0.8
Copper plate	0.06	Gypsum	0.75
Black aluminium	0.95	Oil paint	0.9
Human skin	0.98	Rubber	0.95
Asphalt	0.96	Soil	0.93
PVC plastics	0.93		